

# LAT 61 K 50/20 IUPN

## Laser distance sensor

- Extremely high resolution
- Very small laser spot
- CMOS linear image sensor
- Integrated configuration display
- 2 analog and 3 digital outputs
- Timing- and multifunction input
- Light construction for mounting on moving parts
- High protection class



ANSCHLUSSSCHEMA siehe DOKUMENTE → Beipackzettel S. 2  
 CONNECTION DIAGRAM see DOCUMENTS → Instruction leaflet p. 2  
 SCHÉMA DE CONNEXION voir DOCUMENTS → Notice d'utilisation p. 2

### Safety instructions

Inproper use may result in hazardous radiation exposure. Pay attention to accident prevention rules and laser class. The instruments are not to be used for safety applications, in particular applications in which safety of persons depends on proper operation of the instruments. These instruments shall exclusively be used by qualified personnel.

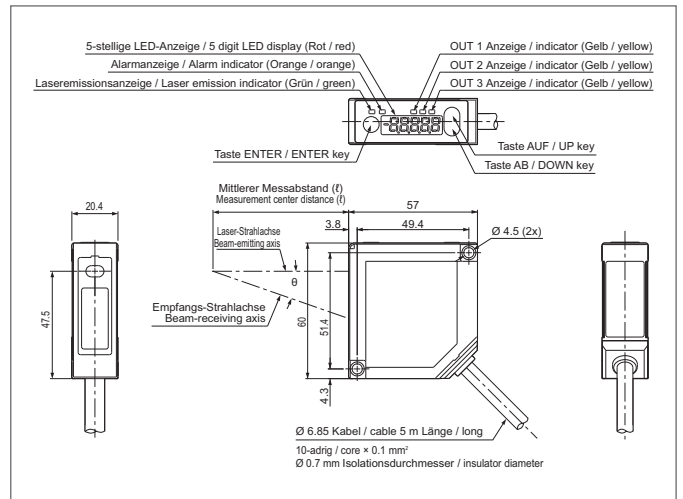

TECHNICAL INFORMATION (typ.)		+20°C, 24V DC
Emitted light		Red light laser, 665 nm
Laser class		2 (IEC 60825-1)
Service voltage		24 V DC ± 10%
Internal power consumption		< 100 mA
Diameter of light spot		0,5 x 1,0 mm
Detection range		40 ... 60 mm
Resolution		1,5 µm
Measuring center distance / Measuring range		50 mm / ± 10 mm
Switching output		pnp/npn (3x), 50 mA, NO/NC, configurable
Analog output		0 ... 10 V, 4 ... 20 mA, linearised
Display		LED for output status, LED yellow (Display output)
Voltage drop		2,8 V
Ambient temperature		-10 ... +45 °C
Vibration/Shock resistance		10 ... 500 Hz / 1,5 mm / 10 G
Ambient light immunity		3 kLx
Insulation voltage endurance		250 V
Protection class		IP 67
Protection degree		III, operation on protective low voltage
Casing material		plastics
Material		Acrylic (Window)
Connection		Cable, 5 m, 10-poled, shielded, flying leads